

HIKVISION

Body Camera Quick Start Guide



Scan the QR code for User
Manual.



Scan the QR code for
Portable Device Assistant
application.



See Far, Go Further

Quick Start Guide

© 2020 Hangzhou Hikvision Digital Technology Co., Ltd.
All rights reserved.

This Manual is the property of Hangzhou Hikvision Digital Technology Co., Ltd. or its affiliates (hereinafter referred to as “Hikvision”), and it cannot be reproduced, changed, translated, or distributed, partially or wholly, by any means, without the prior written permission of Hikvision. Unless otherwise expressly stated herein, Hikvision does not make any warranties, guarantees or representations, express or implied, regarding to the Manual, any information contained herein.

About this Manual

The Manual includes instructions for using and managing the Product. Pictures, charts, images and all other information hereinafter are for description and explanation only. The information contained in the Manual is subject to change, without notice, due to firmware updates or other reasons. Please find the latest version of this Manual at the Hikvision website (<http://www.hikvision.com/en/>).

Please use this Manual with the guidance and assistance of professionals trained in supporting the Product.

Trademarks Acknowledgement

- **HIKVISION** and other Hikvision’s trademarks and logos are the properties of Hikvision in various jurisdictions.
- Other trademarks and logos mentioned are the properties of their respective owners.

LEGAL DISCLAIMER

TO THE MAXIMUM EXTENT PERMITTED BY APPLICABLE LAW, THIS MANUAL AND THE PRODUCT DESCRIBED, WITH ITS HARDWARE, SOFTWARE AND FIRMWARE, ARE PROVIDED “AS IS” AND “WITH ALL FAULTS AND ERRORS”. HIKVISION MAKES NO WARRANTIES, EXPRESS OR IMPLIED, INCLUDING WITHOUT LIMITATION, MERCHANTABILITY, SATISFACTORY QUALITY, OR FITNESS FOR A PARTICULAR PURPOSE. THE USE OF THE PRODUCT BY YOU IS AT YOUR OWN RISK. IN NO EVENT WILL HIKVISION BE LIABLE TO YOU FOR ANY SPECIAL, CONSEQUENTIAL, INCIDENTAL, OR INDIRECT DAMAGES, INCLUDING, AMONG OTHERS, DAMAGES FOR LOSS OF BUSINESS PROFITS, BUSINESS INTERRUPTION, OR LOSS OF DATA, CORRUPTION OF SYSTEMS, OR LOSS OF DOCUMENTATION, WHETHER BASED ON BREACH OF CONTRACT, TORT (INCLUDING NEGLIGENCE), PRODUCT LIABILITY, OR OTHERWISE, IN CONNECTION WITH THE USE OF THE PRODUCT, EVEN IF HIKVISION HAS BEEN ADVISED OF THE POSSIBILITY OF SUCH DAMAGES OR LOSS.

YOU ACKNOWLEDGE THAT THE NATURE OF INTERNET PROVIDES FOR INHERENT SECURITY RISKS, AND HIKVISION SHALL NOT TAKE ANY RESPONSIBILITIES FOR ABNORMAL OPERATION, PRIVACY LEAKAGE OR OTHER DAMAGES RESULTING FROM CYBER-ATTACK, HACKER ATTACK, VIRUS INSPECTION, OR OTHER INTERNET SECURITY RISKS; HOWEVER, HIKVISION WILL PROVIDE TIMELY TECHNICAL SUPPORT IF REQUIRED.

YOU AGREE TO USE THIS PRODUCT IN COMPLIANCE WITH ALL APPLICABLE LAWS, AND YOU ARE SOLELY RESPONSIBLE FOR ENSURING THAT YOUR USE CONFORMS TO THE APPLICABLE LAW. ESPECIALLY, YOU ARE RESPONSIBLE, FOR USING THIS PRODUCT IN A MANNER THAT DOES NOT INFRINGE ON THE RIGHTS OF THIRD PARTIES, INCLUDING WITHOUT LIMITATION, RIGHTS OF PUBLICITY, INTELLECTUAL PROPERTY RIGHTS, OR DATA PROTECTION AND OTHER PRIVACY RIGHTS. YOU

SHALL NOT USE THIS PRODUCT FOR ANY PROHIBITED END-USES, INCLUDING THE DEVELOPMENT OR PRODUCTION OF WEAPONS OF MASS DESTRUCTION, THE DEVELOPMENT OR PRODUCTION OF CHEMICAL OR BIOLOGICAL WEAPONS, ANY ACTIVITIES IN THE CONTEXT RELATED TO ANY NUCLEAR EXPLOSIVE OR UNSAFE NUCLEAR FUEL-CYCLE, OR IN SUPPORT OF HUMAN RIGHTS ABUSES.

IN THE EVENT OF ANY CONFLICTS BETWEEN THIS MANUAL AND THE APPLICABLE LAW, THE LATER PREVAILS.

Regulatory Information

FCC Information

Please take attention that changes or modification not expressly approved by the party responsible for compliance could void the user's authority to operate the equipment.

FCC compliance: Please take attention that changes or modification not expressly approved by the party responsible for compliance could void the user's authority to operate the equipment.

Note: This product has been tested and found to comply with the limits for a Class B digital device, pursuant to Part 15 of the FCC Rules. These limits are designed to provide reasonable protection against harmful interference in a residential installation. This product generates, uses, and can radiate radio frequency energy and, if not installed and used in accordance with the instructions, may cause harmful interference to radio communications. However, there is no guarantee that interference will not occur in a particular installation. If this product does cause harmful interference to radio or television reception, which can be determined by turning the equipment off and on, the user is encouraged to try to correct the interference by one or more of the following measures:

- Reorient or relocate the receiving antenna.
- Increase the separation between the equipment and receiver.
- Connect the equipment into an outlet on a circuit different from that to which the receiver is connected.
- Consult the dealer or an experienced radio/TV technician for help.

This equipment should be installed and operated with a minimum distance 20cm between the radiator and your body.

FCC Conditions

This device complies with part 15 of the FCC Rules. Operation is subject to the following two conditions:

1. This device may not cause harmful interference.
2. This device must accept any interference received, including interference that may cause undesired operation.

EU Conformity Statement



This product and - if applicable - the supplied accessories too are marked with "CE" and comply therefore with the applicable harmonized European standards listed under the Radio Equipment Directive 2014/53./EU, the EMC Directive 2014/30/EU, the LVD Directive 2014/35/EU, the RoHS Directive 2011/65/EU.

2012/19/EU (WEEE directive): Products marked with this symbol cannot be disposed of as unsorted municipal waste in the European Union. For proper recycling, return this product to your local supplier upon the purchase of equivalent new



equipment, or dispose of it at designated collection points. For more information see: www.recyclethis.info. 2006/66/EC (battery directive): This product contains a



battery that cannot be disposed of as unsorted municipal waste in the European Union. See the product documentation for specific battery information. The battery is marked with this symbol, which may

include lettering to indicate cadmium (Cd), lead (Pb), or mercury (Hg). For proper recycling, return the battery to your supplier or to a designated collection point. For more information, see: www.recyclethis.info.

Industry Canada ICES-003 Compliance

This device meets the CAN ICES-3 (B)/NMB-3(B) standards requirements.

This device complies with Industry Canada licence-exempt RSS standard(s). Operation is subject to the following two conditions:

- 1) this device may not cause interference, and
- 2) this device must accept any interference, including interference that may cause undesired operation of the device.

Le présent appareil est conforme aux CNR d'Industrie Canada applicables aux appareils radioexempts de licence. L'exploitation est autorisée aux deux conditions suivantes :

- 1) l'appareil ne doit pas produire de brouillage, et
- 2) l'utilisateur de l'appareil doit accepter tout brouillage radioélectrique subi, même si le brouillage est susceptible d'en compromettre le fonctionnement.



Under Industry Canada regulations, this radio transmitter may only operate using an antenna of a type and maximum (or lesser) gain approved for the transmitter by Industry Canada. To reduce potential radio interference to other users, the antenna type and its gain should be so chosen that the equivalent isotropically radiated power (e.i.r.p.) is not more than that necessary for successful communication.

Conformément à la réglementation d'Industrie Canada, le présent émetteur radio peut

fonctionner avec une antenne d'un type et d'un gain maximal (ou inférieur) approuvé pour l'émetteur par Industrie Canada. Dans le but de réduire les risques de brouillage radioélectrique à l'intention des autres utilisateurs, il faut choisir le type d'antenne et son gain de sorte que la puissance isotrope rayonnée équivalente (p.i.r.e.) ne dépasse pas l'intensité nécessaire à l'établissement d'une communication satisfaisante.

Symbol Conventions

The symbols that may be found in this document are defined as follows.

Symbol	Description
	Provides additional information to emphasize or supplement important points of the main text.
	Indicates a potentially hazardous situation, which if not avoided, could result in equipment damage, data loss, performance degradation, or unexpected results.



Indicates a hazard with a high level of risk, which if not avoided, will result in death or serious injury.

Safety Instruction

Laws and Regulations

Use of the product must be in strict compliance with the local laws and regulations. Please shut down the device in prohibited area.

Power Supply

- Use of the product must be in strict compliance with the local electrical safety regulations.
- Use the power adapter provided by qualified manufacturer. Refer to the product specification for detailed power requirements.
- It is recommended to provide independent power adapter for each device as adapter overload may cause over-heating or a fire hazard.
- Make sure that the power has been disconnected before you wire, install, or disassemble the device.
- DO NOT directly touch exposed contacts and components once the device is powered up to avoid electric shock.
- DO NOT use damaged power supply devices (e.g., cable, power adapter, etc.) to avoid electric shock, fire hazard, and explosion.
- DO NOT directly cut the power supply to shut down the device. Please shut down the device normally and then unplug the power cord to avoid data loss.
- DO NOT block the power supply equipment to plug and unplug conveniently.
- Make sure the power supply has been disconnected if the power adapter is idle.
- Make sure the device is connected to the ground firmly.

Transportation, Use, and Storage

- To avoid heat accumulation, good ventilation is required for a proper operating environment.
- Store the device in dry, well-ventilated, corrosive-gas-free, no direct sunlight, and no heating source environment.
- Avoid fire, water, and explosive environment when using the device.
- Avoid lightning strike for device installation. Install a lightning arrester if necessary.
- Keep the device away from magnetic interference.
- Avoid device installation on vibratory surface or places, and avoid equipment installation on vibratory surface or places subject to shock (ignorance may cause device damage).
- DO NOT touch the heat dissipation component to avoid burns.
- DO NOT expose the device to extremely hot, cold, or humidity environments. For temperature and humidity requirements, see device specification.
- The device can only be safely used in the region below 2000 meters above the sea level.

Maintenance

- If smoke, odor, or noise arises from the device, immediately turn off the power, unplug the power cable, and contact the service center.
- If the device is abnormal, contact the store you purchased it or the nearest service center. DO NOT disassemble or modify the device in any way (For the problems caused by unauthorized modification or maintenance, the company shall not take any responsibility).
- Keep all wrappers after unpacking them for future use. In case of any failure occurred, you need to return the device to the factory with the original wrapper. Transportation without the original wrapper may result

in damage to the device and the company shall not take any responsibility.

Network

- Please enforce the protection for the personal information and the data security as the device may be confronted with the network security problems when it is connected to the Internet. Please contact us when the device might exist network security risks.
- Please understand that you have the responsibility to configure all the passwords and other security settings about the device, and keep your user name and password.

Lens

- DO NOT touch the lens with fingers directly in case the acidic sweat of the fingers erodes the surface coating of the lens.
- DO NOT aim the lens at the strong light such as sun or incandescent lamp. The strong light can cause fatal damage to the device.

Screen

Clean the screen with soft and dry cloth or other substitutes to wipe the interior and exterior surface. DO NOT use alkaline detergents. Protect the screen from scratches.

Battery

- DO NOT charge the battery continuously more than one week. Overcharging may shorten the battery life.
- Battery will discharge gradually if it is not used for a long time. It must be recharged before using.
- If the device contains dismountable battery, store the device and battery separately if it is not used.
- The battery must be charged and discharged every three months if it is not used, and recharged to 60% to 70% power percentage to store.
- The scrapped battery should be discarded in compliance with the local laws and regulations. If there are no corresponding laws or regulations, throw it in a hazardous trash can.
- DO NOT pierce the battery or shorten the electrodes, or it may cause explosion or fire hazard.
- DO NOT throw the battery in fire or water, or it may cause explosion.
- Please use the specific battery supported by the device, or it may cause explosion. If the battery is damaged and needs to be changed, contact the device manufacturer or local distributor.
- If the device contains button battery, keep it far away from children.
- DO NOT expose the battery pack or battery combination to sunlight, fire, or similar overheated environment.

Data

DO NOT disconnect the power during formatting, uploading, and downloading. Or files may be damaged.

1 Product Introduction

1.1 Introduction

Body camera is typically used by law enforcement officers to record video, tape audio, and capture picture to gather evidence.

1.2 Packing List

Following objects are included in package. If something loses, contact us or our supplier.

- 1 × Body camera
- 1 × shoulder clip
- 1 × USB data cable
- 1 × Charger
- 1 × Battery
- 1 × Printed quick start guide

1.3 Appearance

Refer to Figure 1-1 for the appearance of the body camera.

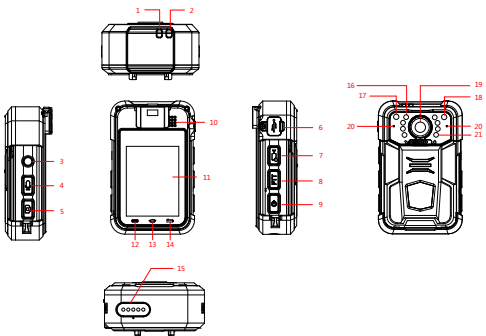





Figure 1-1 Appearance

Table 1-1 Appearance Description

No.	Name	Description
1	LED 1	When body camera is being charged, it is solid red. When body camera is fully charged, it is solid green. When body camera is recording, it flashes in red with low frequency.
2	LED 2	When body camera is working, it is solid green. When body camera is taping audio, it flashes in yellow.
3	SOS	In emergency, hold it for more than 1 second to alarm manually and send the alarm to the platform.
4	Taping	Press it to start/stop taping. During recording or taping, hold it for 3 seconds to tag the video or audio file. Hold it again to cancel tag.

No.	Name	Description
5	Capture	Press it to capture current live view image.
6	USB interface	Connect USB cable or charger to it.
7	Recording	Press it to start/stop recording. Hold it for 3 seconds to turn on laser positioning light. When body camera is shut down, hold it for 3 seconds to start it up and start recording.
8	PTT	Hold it and the body camera can work as a MIC or loudspeaker for two-way audio.
9	On/Off	When body camera is off, hold it for 3 seconds to start it up. When body camera is on, hold it for 3 seconds to shut it down. After body camera is started up, press it to inactivate/activate LCD.
10	Loudspeaker	Loudspeaker.
11	LCD	It displays local menu and live view image.
12		On some pages, tap it and the shortcut menu will pop up.
13		Tap it to switch to camera. Hold it to list the software process.
14		Tap it to return to the upper menu.
15	Expansion interface	Connect it to the cradle for charging or data transmission. The cradle is optional.
16	White light	It supplies light at dark environment.
17	Photosensitive sensor	It is used for IR switch of camera.
18	Laser positioning light	You can turn on the laser positioning light to judge the position when recording or capturing.
19	Lens	Lens.
20	MIC	MIC.

No.	Name	Description
21	IR Light	You can turn on the IR light to supply body camera sufficient light to get a visible image.

2 Installation

2.1 Install Shoulder Clip

The shoulder clip helps you to fix the body camera on your garment. The vertical adjustable angle is 360°.

Steps:

1. Insert the shoulder clip down into the slot on the front panel of the body camera.

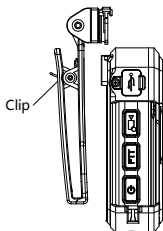

Figure 2-1 Install Shoulder Clip

2. Check if the clip is inserted into the slot firmly.

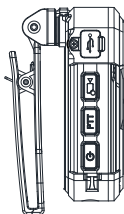

Figure 2-2 Successful Installation

2.2 Uninstall Shoulder Clip

You can uninstall the shoulder clip if you do not want to wear the device on your shoulder.

Steps:

1. Press the buckles on both sides of the clip inwards with your fingers.

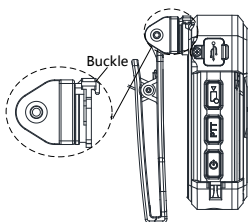

Figure 2-3 Press Buckles

2. Slide the clip upwards to uninstall it.

2.3 Charge Body Camera

When the body camera power is low, charge it in time.

1. Open the cover of USB interface on one side of the body camera.
2. Connect the body camera to the charger with the USB data cable.

i NOTE

- When the body camera is being charged, LED 1 is solid red. When it is fully charged, LED 1 is solid green.
- You can enable quick charging mode. In quick charging mode, all the power consuming functions will be disabled, including network, recording, positioning, etc.

2.4 Install Battery

When the body camera is in low battery, LED1 flashes in red with high frequency. In this condition, charge it in time or change the battery.

1. Slide the fastener on the rear panel of the body camera to the left.

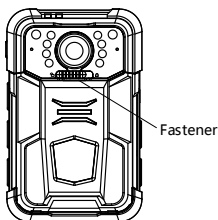

Figure 2-4 Slide Fastener

2. Open the back cover by pulling the protruding handles.

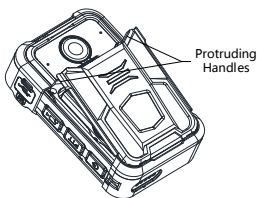

Figure 2-5 Open Back Cover

3. Take the battery out by pulling the battery handle.
4. Change a battery.
5. Install the back cover.
6. Slide the fastener to the right to lock the back cover.

2.5 Install 3G/4G MicroSIM Card

Install a 3G/4G microSIM card on the body camera if you want to connect to the network via 3G/4G microSIM card. Shut down the body camera before the installation.

i NOTE

This chapter is only applicable to the body camera supporting 3G/4G.

1. Open the back cover and take the battery out. Refer to 2.3 Charge Body Camera for details.
2. Open the sheet metal of the card slot, and put the card into the slot with the metal side facing down.
3. Push the sheet metal forwards to lock the card.

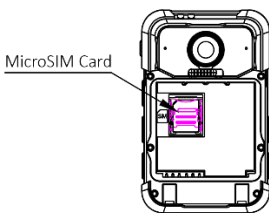

Figure 2-6 Install 3G/4G MicroSIM Card

4. Push the sheet metal forwards to lock the card.
5. Install the battery and back cover.
6. Slide the fastener to the right to lock the back cover.

2.6 Install Body Camera Assistant

You can configure the body camera and download files via the Body Camera Assistant (hereinafter referred to as software). Get the software from the official website (<https://www.hikvision.com/>).

1. Double click the software to start installation.

NOTE

- Install *BodyCameraAssistant-win32.exe* if your computer is in 32-bit operating system.
 - Install *BodyCameraAssistant-win64.exe* if your computer is in 64-bit operating system.
2. Follow the wizard to install the assistant.

3 Basic Operation

3.1 Zoom

You can zoom in/out the live view image to get the best recording or capturing effect.

On Camera page, tap . The lens will zoom in when the multiple increases, and zoom out when the multiple decreases.

3.2 Dial

You can connect the body camera to internet via 3G/4G dialing.

NOTE

This function is only applicable to the body camera supporting 3G/4G.

Before you start:

Install 3G/4G microSIM card. Refer to 2.5 Install 3G/4G MicroSIM Card.

Steps:

1. Slide the screen down to open the notification center.
2. Tap  to enable 3G/4G dialing.

3.3 Storage

You can record video, tape audio, and capture picture via the body camera.

3.3.1 Format Storage Media

When the memory of storage media is full, you can format it to clear the data.

Before you start:

- Connect the body camera to the computer via data cable.
- Log in to the Body Camera Assistant.



Back up the files in the storage media before formatting to avoid data loss.

1. Go to **Device Configuration > System Settings**.
2. Click **Format**.
3. Enter the password.
4. Click **OK**.

3.3.2 Record

You can record video via the body camera.

1. Press . appears on the status bar, indicating the body camera is recording.
2. Press the button again to stop recording.
3. (Optional) Tap **File MGT** on the main menu to view the video files.



- If you want to record a period of time before recording starts, tap **Settings > System > Pre-record** to set pre-record.
- If you want to record a period of time after recording ends, tap **Settings > System > Post-record** to set post-record.

3.3.3 Tape

You can tape audio via the body camera.

1. Press . appears on the status bar, indicating the body camera is taping.
2. Press the button again to stop taping.
3. (Optional) Tap **File MGT** on the main menu to view the audio files.

3.3.4 Capture

You can capture pictures via the body camera.

1. Press to capture picture.
2. (Optional) Tap **File MGT** on the main menu to view the captured pictures.

3.4 Playback

You can play back video, audio, and picture via the body camera.

1. Tap **File MGT** on the main menu.
2. Tap **Video, Audio, or Picture**.
3. Select the file in the list to play back or view.

4 FAQ

● Unable to start up.

- a) **Possible Reason:** Device runs out of power.

Solution: Charge the device.

- b) **Possible Reason:** The battery is damaged or runs out of power.

Solution: Change battery.

● Unable to start recording.

- a) **Possible Reason:** Memory is full.

Solution: Back up device and clear device memory.

- b) **Possible Reason:** Formatting storage media error.

Solution: Format storage media via assistant. Refer to 3.3.1 Format Storage Media.

- c) **Possible Reason:** Device is abnormal.

- Solution:** Reboot device.
- **Unable to dial.**
 - a) **Possible Reason:** Wi-Fi is enabled and connected.
Solution: Disable Wi-Fi.
 - b) **Possible Reason:** 3G/4G microSIM card is not installed well.
Solution: Reinstall 3G/4G microSIM card.
 - c) **Possible Reason:** 3G/4G microSIM card is fees owed.
Solution: Renew the card.
 - d) **Possible Reason:** Device is abnormal.
Solution: Reboot device.
- **Unable to log in.**
 - a) **Possible Reason:** Password error.
Solution: Reset your password.
 - b) **Possible Reason:** Device is abnormal.
Solution: Reboot device.